

T9 Push-to-Close Latch

Pull-to-open · Cabinet catches

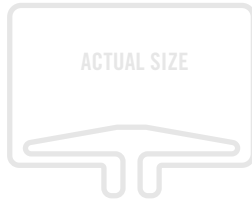

Catches

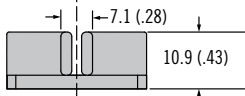
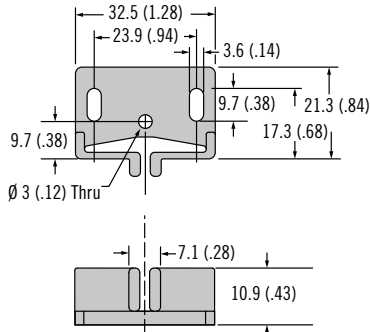

Keeper

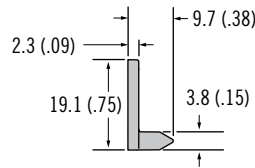
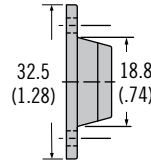
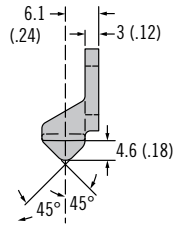

Color	Part Number
Black	T9-10-101-50
White	T9-10-101-70

- Detent action
- Non-corrosive and non-conductive

Material and Finish

Latch and keeper:

Acetal, black or white

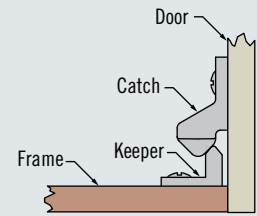

www.southco.com/T9